

DAS FOTOGRAPHE
buy a picture.de



DEUTSCHE
QUARTER
HORSE
ASSOCIATION
*Regionen-
Futurity Nord*

DEUTSCHE
QUARTER
HORSE
ASSOCIATION
*Regionen-
Futurity Nord*



Nord Futurity 2023

Niedersachsenhalle Verden
01.09.-03.09.2023

DEUTSCHE
QUARTER
HORSE
ASSOCIATION

*Regionen-
Futurity Nord*



TURNIERFOTOS

Während dieser Veranstaltungen werden von einem Team von buy-a-picture.de zum Zwecke der Öffentlichkeitsarbeit Fotos gemacht. Die Bilder können außerdem nach der Show von den Teilnehmern über unseren Shop erworben werden:

DAS PFERDEFOTO
buy-a-picture.de

Vorsicht
Kamera

Du möchtest nicht fotografiert werden? Kein Problem.
Sprich uns Fotografen gerne hier vor Ort an. Oder kontaktiere uns von daheim:
Maike Thorun • Aegidienberger Str. 33 • 53604 Bad Honnef
T: 02224 989992 • welcome@buy-a-picture.de
Mehr Infos findest du auf unserer Webseite www.buy-a-picture.de:
Unter dem Menüpunkt „AGB“ gibt es Details zu unseren Lizenzkonditionen.
Und unter „Datenschutz“ erklären wir, wie wir mit deinen Daten umgehen.



PS: Hinter uns ist übrigens der sicherste Platz, um nicht fotografiert zu werden...

Your best pictures on www.buy-a-picture.de

Grußwort

Liebe Teilnehmer,
Liebe Freunde und Förderer
des American Quarter Horse,



im Namen des Vorstandes der DQHA Nord und des Showteams, möchte ich euch ganz herzlich auf der diesjährigen Nord Futurity willkommen heißen.

Wir freuen uns sehr, euch wieder einmal in der wundervollen Niedersachsenhalle in Verden begrüßen zu dürfen. Die vielen positiven Stimmen über das ganze Jahr verteilt lassen mich die Nord Futurity zurecht den Saisonhöhepunkt der Quarter Horse Fans im Norden nennen.

Erneut sind wir überwältigt von den vielen tollen Sponsoren und möchten uns bei jedem einzelnen ganz herzlich dafür bedanken.

Es ist toll zu sehen, dass wieder viele Teilnehmer nach Verden gekommen sind, um sowohl in den DQHA Futurity und Maturity Klassen an den Start zu gehen, als auch um die Titel des Regio Nord und des Nord Circuit Champions zu reiten. Unser Team hat wieder einmal alles perfekt vorbereitet und freut sich nun euch durch die Show zu begleiten. Danke an das gesamte Team, ihr seid einfach Spitze!

Ich wünsche alle Teilnehmern und Pferdebesitzern viel Spaß und Erfolg!

Tanja Klahr

Regionalgruppendifektorin DQHA Nord



Organisation

Veranstalter: DQHA e.V.
 Showmanager: Hellfried Kurzac
 Show Office: Stefanie Schulz
 Telefon: +495131/5028102
 Richter: Stefanie Bubenzer & Pierre Ouellet
 Ringstewards: Sandra Visnjic & Regina Knollmann
 Doorman: Jill Jennifer Bozic
 Parcoursdienst: Nico Weber
 Ergebnisdienst: Lea Webersinn
 Siegerehrungen: Marlene Eicke
 Presse & Social Media: Sara Moslehner
 Ansage: Martin Schwabe
 Boxen, Parkplatz, Camper: Janine Leuschner
 Heuabgabe: Meldestelle
 Tierarzt: Tierarztpraxis Ottersberg
 Telefon 04205/31790
 Hufschmied: Gert Meyer
 Telefon 0170/9019562 (Rufbereitschaft)
 Sanitätsdienst: Martin Schwabe
 Fotograf: buy-a-picture.de
 Maike Thorun und Roberto Robaldo



Zeitplan Regionen-Futurity Nord 2022

Die Anreise ist am Donnerstag, 01.09.2023 erst ab 12 Uhr möglich!

Donnerstag, 31.08.2023 - Beginn 14:00 Uhr

Öffnung der Meldestelle 12:00 Uhr

Paid warm up Trail 3er Gruppen

Freies Abreiten

Paid Warm Up Pleasure

Paid Warm Up Longe Line 2er Gruppen

Abziehen

Paid Warm up Reining /Ranch Riding

* Das Showmanagement behält sich das Recht vor, die Klassen bis zu 30 Minuten vor den in der vorläufigen Zeiteinteilung angegebenen Uhrzeiten beginnen zu lassen!

Uhrzeit	Starter
14:00	39
ca. 17:45	
ca. 18:05	16
ca. 19:05	11
ca. 19:30	
ca. 19:45	3

Freitag, 01.09.2023 - Beginn 9:00 Uhr

Öffnung der Meldestelle 08:00 Uhr

AQHA 138004 Trail L1 Open (Green)

AQHA 238002 Trail L1 Amateur

AQHA 138200 Senior Trail Open

AQHA 238000 Trail Amateur

AQHA 142004 Western Pleasure L1 Open (Green)

AQHA 240002 Western Horsemanship L1 Amateur

Horsemanship Open Quali

Mittagspause

AQHA 236002 Western Riding L1 Amateur

NSBA Germany Longe Line 2 jährige Open

AQHA 143004 Ranch Riding L1 Open (Green)

DQHA 9431 Ranch Riding Futurity (4-6 jährige)

AQHA 143000 Ranch Riding Open

AQHA 144004 Hunter Unter Saddle L1 Open (Green)

AQHA 244002 Hunter under Saddle L1 Amateur

DQHA 9441 Hunter under Saddle Futurity (4-6 jährige)

NSBA Germany Longe Line 3 jährige

Uhrzeit	Starter
09:00	20
	9
	5
	7
ca. 12:25	10
	10
	4
ca. 13:30	
ca. 14:15	1
ca. 14:20	7
	2
	3
	1
ca. 16:00	6
	9
	12
ca. 17:30	4

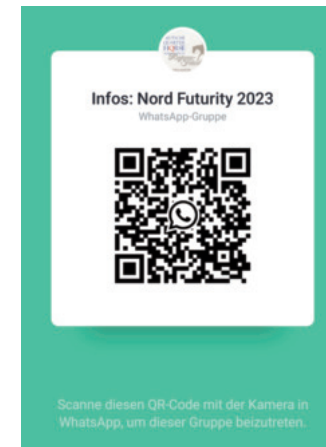

Samstag, 02.09.2023 - Beginn 7:00 Uhr

Öffnung der Meldestelle 06:15 Uhr

AQHA 103000/DQHA 9030 Weanling Stallions Open/Futurity	07:00	0
AQHA 103100/DQHA 9031 Yearling Stallions Open/Futurity		3
AQHA 103200/DQHA 9032 Two Year Old Stallions Open/Futurity		2
AQHA 103300/DQHA 9033 Three Year Old Stallions Open/Futurity		0
AQHA 103400 Aged Stallions Open		0
AQHA 173000 Performance Halter Stallions Open		0
AQHA 203000 Weanlings Stallions Amateur		0
AQHA 203100 Yearling Stallions Amateur		3
AQHA 203200 Two Year Old Stallions Amateur		1
AQHA 203300 Three Year Old Stallions Amateur		0
AQHA 203400 Aged Stallions Amateur		0
AQHA 273000 Performance Halter Stallions Amateur		0
AQHA 107400/DQHA 9074 Yearling Geldings Open/Futurity		2
AQHA 107500/DQHA 9075 Two Year Old Geldings Open/Futurity		5
AQHA 107600/DQHA 9076 Three Year Old Geldings Open/Futurity		7
AQHA 107700 Aged Geldings Open		3
AQHA 177000 Performance Halter Geldings Open		0
AQHA 207400 Yearling Geldings Amateur		1
AQHA 207500 Two Year Old Geldings Amateur		2
AQHA 207600 Three Year Old Geldings Amateur		5
AQHA 207700 Aged Geldings Amateur		4
AQHA 277000 Performance Halter Geldings Amateur		1
AQHA 407400 Yearling Geldings Youth		0
AQHA 407500 Two Year old Geldings Youth		0
AQHA 407600 Three Year old Geldings Youth		0
AQHA 407700 Ages Geldings Youth		2
AQHA 477000 Performance Halter Geldings Youth		0
AQHA 105300/DQHA 9053 Weanling Mares Open/Futurity		2
AQHA 105400/DQHA Yearling Mares Open/Futurity		3
AQHA 105500/DQHA 9054 Two Year Old Mares Open/Futurity		8
AQHA 105600/DQHA 9055 Three Year Old Mares Open/Futurity		8
AQHA 105700 Aged Mares Open		9
AQHA 175000 Performance Halter Mares Open		0
AQHA 205300 Weanling Mares Amateur		1
AQHA 205400 Yearling Mares Amateur		2
AQHA 205500 Two Year Old Mares Amateur		7
AQHA 205600 Three Year Old Mares Amateur		1
AQHA 205700 Aged Mares Amateur		9
AQHA 275000 Performance Halter Mares Amateur		0
AQHA 405400 Yearling Mares Youth		0
AQHA 405500 Two Year old Mares Youth		1
AQHA 405600 Three Year old Mares Youth		1
AQHA 405700 Ages Mares Youth		2
AQHA 475000 Performance Halter Mares Youth		0
Mittagspause	ca. 12:00	
AQHA 212002 Showmanship at Halter L1 Amateur	ca. 12:45	14
AQHA 412002 Showmanship at Halter L1 Youth		3
AQHA 212000 Showmanship at Halter Amateur		11
AQHA 412000 Showmanship at Halter Youth		4
DQHA 9002 Longe Line 2 year old Futurity	ca. 14:40	12
AQHA 442102 Walk Trot Western Pleasure L1 Youth	ca. 15:30	3
AQHA 142100 Junior Western Pleasure Open		6
DQHA 9421 Western Pleasure Futurity (4-6 jährige)		17
AQHA 242002 Western Pleasure L1 Amateur		12
AQHA 440102 Walk Trot Western Horsemanship L1 Youth	ca. 17:10	2
AQHA 440002 Western Horsemanship L1 Youth		2
AQHA 240000 Western Horsemanship Amateur		8
AQHA 440000 Western Horsemanship Youth		2
AQHA 144000 Hunter Unter Saddle Open	ca.18:15	8
DQHA 9442 Hunter Under Saddle Maturity (7-9 jährige)		5
AQHA 444002 Hunter under Saddle L1 Youth		1
AQHA 244000 Hunter under Saddle Amateur		6
DQHA 9003 Longe Line 3 year old Futurity	ca. 19:40	11
Golden Horsemanship	ca. 20:30	

** Das Showmanagement behält sich das Recht vor, die Klassen bis zu 30 Minuten vor den in der vorläufigen Zeiteinteilung angegebenen Uhrzeiten beginnen zu lassen!*

Sonntag, 03.09.2023 - Beginn 8:00 Uhr

Öffnung der Meldestelle 07:15 Uhr

DQHA 93802 Trail in Hand Futurity (2 jährige)	08:00	10
DQHA 93803 Trail in Hand Futurity (3 jährige)		13
AQHA 138100 Junior Trail Open		9
DQHA 9381 Trail Futurity (4-6 jährige)		16
AQHA 438100 Walk Trot Trail L1 Youth		1
AQHA 438002 Trail L1 Youth		3
AQHA 438000 Trail Youth		2
DQHA 9382 Trail Maturity (7-9 jährige)		3
ROLL Lead Line	ca. 12:40	5
Mittagspause	ca. 13:00	
NSBA Germany 5440 Hunter Under Saddle Open		10
AQHA 252002 Hunt Seat Equitation L1 Amateur		6
AQHA 252000 Hunt Seat Equitation Amateur		6
AQHA 242000 Western Pleasure Amateur		5
AQHA 142200 Senior Western Pleasure		2
DQHA 9422 Western Pleasure Maturity (7-9 jährige)		4
AQHA 442000 Western Pleasure Youth		1
Working Western Rail Youth		1
NSBA Germany Western Pleasure Open		7
AQHA 243002 Ranch Riding L1 Amateur		3
AQHA 443002 Ranch Riding L1 Youth		2
AQHA 234000 Ranch Riding Amateur		1

** Das Showmanagement behält sich das Recht vor, die Klassen bis zu 30 Minuten vor den in der vorläufigen Zeiteinteilung angegebenen Uhrzeiten beginnen zu lassen!*

DEUTSCHE
QUARTER
HORSE
ASSOCIATION

Regionen-
Futurity Nord



Teilnehmerliste

DQHA Regionen-Futurity Nord

Start Nr.	Pferd	JahrSex	Eigentümer	Nat.	Vorsteller	Nat.
102	VS Loveline	2018 M	Joanna Rohwer	DE	Joanna Rohwer	DE
107	One Radical Melody	2015 M	Joanna Rohwer	DE	Joanna Rohwer	DE
118	Nobodyz Business	2019 G	Nancy Van Aken	BE	Barbara Ceusters	BE
118	Nobodyz Business	2019 G	Nancy Van Aken	BE	Nancy Van Aken	BE
120	Its A Goodbar Thing	2020 G	Nancy Van Aken	BE	Barbara Ceusters	BE
120	Its A Goodbar Thing	2020 G	Nancy Van Aken	BE	Nancy Van Aken	BE
123	In My Blood	2018 M	Nancy Van Aken	BE	Barbara Ceusters	BE
123	In My Blood	2018 M	Nancy Van Aken	BE	Nancy Van Aken	BE
135	Good Rascals Impulse	2012 G	Nina Michaelsen	DE	Arne Kuehn	DE
135	Good Rascals Impulse	2012 G	Nina Michaelsen	DE	Nieke Michaelsen	DE
135	Good Rascals Impulse	2012 G	Nina Michaelsen	DE	Nina Michaelsen	DE
138	Got Southern Credit	2015 G	Amelie Busse	DE	Amelie Busse	DE
138	Got Southern Credit	2015 G	Amelie Busse	DE	Arne Kuehn	DE
143	DM Molly Malone	2021 M	Janine Kortmann	DE	Janine Kortmann	DE
144	CL Undressed	2013 G	Mareike Asmussen	DE	Mareike Asmussen	DE
149	DR Harley Quinn	2020 M	Lara Daekena	DE	Lara Daekena	DE
168	Hotkrymsuninvestment	2018 G	Hauke Themer	DE	Hauke Themer	DE
172	Bona Fide Touch	2009 G	Melanie Towet	DE	Alexander Eck	DE
172	Bona Fide Touch	2009 G	Melanie Towet	DE	Melanie Towet	DE
178	An Undeniably Mayday	2018 G	Serafine Zodrow	DE	Serafine Zodrow	DE
192	Yankee Solano	2007 M	Maren Matern	DE	Solveig Katharina Muke	DE
195	Marylou Rocks	2019 M	Nikola Buerig	DE	Nikola Buerig	DE
196	Girlsnight	2020 M	Nikola Buerig	DE	Nikola Buerig	DE
214	Best Spark	2017 G	Jan-Niklas Barre	DE	Anna-Lena Barre	DE
221	B Dun Whiz Gold	2009 G	Anna-Lena Barre	DE	Marlene Eicke	DE
221	B Dun Whiz Gold	2009 G	Anna-Lena Barre	DE	Sarah-Christin Barre	DE
254	AM Sherlock Holmes	2011 G	Sophia Reinfelder	DE	Sophia Reinfelder	DE
267	A Special Chocolate	2010 G	Sarah-Christin Barre	DE	Anna-Lena Barre	DE
267	A Special Chocolate	2010 G	Sarah-Christin Barre	DE	Jan-Niklas Barre	DE
268	Blumotion	2021 G	Alexander Eck	DE	Alexander Eck	DE
269	Tinn Cup	2020 M	Alena Albrecht	DE	Alena Albrecht	DE
269	Tinn Cup	2020 M	Alena Albrecht	DE	Alexander Eck	DE
270	Keep Distance	2021 G	Jagfeld Quarter Horses	DE	Alexandra Jagfeld	DE
271	HC Lilly Be Invited	2020 M	Caroline Kretzschmar	DE	Caroline Kretzschmar	DE
272	Born Victorious	2018 G	Stefanie Hoehn	DE	Marit Hoehn	DE
273	Royal Ruler	2020 G	Stefanie Hoehn	DE	Stefanie Hoehn	DE
274	Zippos Pretty Rosie	2017 M	Patricia Klischan-Tornquist	DE	Patricia Klischan-Tornquist	DE

Teilnehmerliste

DQHA Regionen-Futurity Nord

Start Nr.	Pferd	JahrSex	Eigentümer	Nat.	Vorsteller	Nat.
275	Hotkrymsunpotential	2019 G	Sandra Kaden	DE	Sandra Kaden	DE
276	WB Smooth Oreo	2022 S	Christine Petersen	DE	Christine Petersen	DE
277	WB Long John Silver	2022 S	Christine Petersen	DE	Clemens Huebner	DE
278	MD Invitemetotexas	2022 G	Dietmar & Maria Friedhoff	DE	Anna-Elisabeth Laves	DE
278	MD Invitemetotexas	2022 G	Dietmar & Maria Friedhoff	DE	Dietmar Friedhoff	DE
279	Candys Magic Shine	2020 G	Dietmar & Maria Friedhoff	DE	Anna-Elisabeth Laves	DE
279	Candys Magic Shine	2020 G	Dietmar & Maria Friedhoff	DE	Dietmar Friedhoff	DE
280	HC Remember Me Sexy	2018 M	Soehngen Lena And Johanna Hippe	DE	Johanna Hippe	DE
280	HC Remember Me Sexy	2018 M	Soehngen Lena And Johanna Hippe	DE	Lena Soehngen	DE
281	Itsasouthernromance	2020 G	Esther Van De Grootvheen	NL	Esther Van De Grootvheen	NL
282	Show Me The Moonlite	2021 G	Sandra Semmler	DE	Sandra Semmler	DE
283	A Dream Of Jeannie	2018 G	Finja Hoerich	DE	Angelina Siemon	DE
283	A Dream Of Jeannie	2018 G	Finja Hoerich	DE	Finja Hoerich	DE
283	A Dream Of Jeannie	2018 G	Finja Hoerich	DE	Hanna Hoerich	DE
284	Spot Dot Com	2017 G	Janina Mueller	DE	Angelina Siemon	DE
285	Its Automatic	2020 M	Angelina Siemon	DE	Finja Hoerich	DE
286	Marlanas Hot Iron	2017 M	Janine Kothe	DE	Ben Kothe	DE
286	Marlanas Hot Iron	2017 M	Janine Kothe	DE	Janine Kothe	DE
286	Marlanas Hot Iron	2017 M	Janine Kothe	DE	Timo Kothe	DE
287	Keep On Rocknroll	2017 G	Philipp Roos	CH	Alexandra Jagfeld	DE
288	Invite Me Solo	2020 G	Philipp Roos	CH	Alexandra Jagfeld	DE
289	Mec Peppyshotwilliam	2021 S	Oliver Mecklenborg	DE	Lea Mecklenborg	DE
290	JP Looks Like Ivory	2021 M	Oliver Mecklenborg	DE	Mechthild Mecklenborg	DE
291	HC Born Western	2021 M	Lisa Hinrichs	DE	Lisa Hinrichs	DE
292	Blazing Lovemachine	2021 M	Morten Ehlers	DE	Emma Lucie Ehlers	DE
292	Blazing Lovemachine	2021 M	Morten Ehlers	DE	Morten Ehlers	DE
293	Blue Shine Of Glory	2022 M	Nina Doert	DE	Nina Doert	DE
294	Best Shine Of Glory	2023 M	Nina Doert	DE	Nina Doert	DE
295	Hotlines Only	2021 S	Joanna Precht	DE	Joanna Precht	DE
296	Good Lopen Lady	2021 M	Tizia Hucklenbroch	DE	Fee Kleine	DE
297	Snuggle In Motion	2020 G	Nadja Lamers	DE	Sarah De Weerd	NL
298	Only Best Of Thing	2020 M	Laura Sasse	DE	Laura Sasse	DE
299	Princessofsecrets	2011 M	Gabriele Fischer	DE	Alexandra Jagfeld	DE
299	Princessofsecrets	2011 M	Gabriele Fischer	DE	Gabriele Fischer	DE
300	Aint Your Mama	2021 M	Fine Art QH	DE	Alexander Eck	DE
301	Kissesinthemoonlight	2019 M	Fine Art QH	DE	Alexander Eck	DE
302	Electricmajesticflow	2017 G	Maren Matern	DE	Solveig Katharina Muke	DE

Teilnehmerliste

DQHA Regionen-Futurity Nord

Start Nr.	Pferd	Jahr/SEX	Eigentümer	Nat.	Vorsteller	Nat.
303	KrymsunBlazinMachine	2017 G	Kim Blockus	DE	Kim Blockus	DE
304	Ridingonawiselydream	2021 M	Saskia Puls Loiti	DE	Kaill Sebastian Loiti	DE
304	Ridingonawiselydream	2021 M	Saskia Puls Loiti	DE	Kim Blockus	DE
304	Ridingonawiselydream	2021 M	Saskia Puls Loiti	DE	Saskia Puls Loiti	DE
305	GQH Hez Good Too	2019 G	Kathrin Roesel	DE	Kathrin Roesel	DE
305	GQH Hez Good Too	2019 G	Kathrin Roesel	DE	Kim Blockus	DE
306	Only Stars Tonite	2017 M	Miriam Sasse	DE	Luisa Lamprecht	DE
306	Only Stars Tonite	2017 M	Miriam Sasse	DE	Miriam Sasse	DE
307	Mec Me Happy	2019 G	Adrien Delporte	BE	Leana Brasseler	DE
308	Minnie Mouze	2019 M	Fine Art QH	DE	Leana Brasseler	DE
309	Dream Of Midnight	2020 G	Regina Jentsch	DE	Regina Jentsch	DE
310	Daddys Machine	2021 G	Stella Rost	DE	Stella Rost	DE
311	BB Blazin	2021 M	Arthur Or Ines Melcher	DE	Stella Rost	DE
313	Gunwilsons Queeny	2018 M	Sabrina Busch	DE	Sabrina Busch	DE
314	TL Onehot Investment	2014 M	Luca Kempfer	DE	Luca Kempfer	DE
315	Licence To Kiss	2021 G	Katharina Schulze	DE	Katharina Schulze	DE
316	Iota Wisely Invested	2016 G	Katharina Schulze	DE	Katharina Schulze	DE
317	Sonnys Deemotional	2015 G	Jutta Bartels	DE	Philipp Dammann	DE
318	QT Smart Spike	2020 G	Doreen Seevogel	DE	Doreen Seevogel	DE
319	Only Made In China	2017 G	Sara Moslehner	DE	Sara Moslehner	DE
320	Need I Luke Good	2020 G	Christin Wendelken	DE	Christin Wendelken	DE
321	MJ Princess Blue	2021 M	Andreas Heinrich	DE	Laura-Sophie Heinrich	DE
321	MJ Princess Blue	2021 M	Andreas Heinrich	DE	Philipp Dammann	DE
322	Scotch An Moonlite	2022 G	Daniela Rohrseitz	DE	Sarah Bode	DE
323	Rockin Wisely	2013 M	Tizia Hucklenbroch	DE	Ina Kleine	DE
323	Rockin Wisely	2013 M	Tizia Hucklenbroch	DE	Tizia Hucklenbroch	DE
324	JT Technical Spot On	2023 M	Svenja Rebecca Jordan	DE	Svenja Rebecca Jordan	DE
325	AM Precious	2020 M	Franziska Hattensauer	DE	Franziska Hattensauer	DE
326	HC Grace Kelly	2020 M	Louisa Heinsch	DE	Louisa Heinsch	DE
327	Struttin To My Blues	2015 M	Monika Knipschild	DE	Angelina Siemon	DE
327	Struttin To My Blues	2015 M	Monika Knipschild	DE	Carolin Knipschild	DE
328	VS Dear Blue Darling	2022 M	Caroline Seidel	DE	Caroline Seidel	DE
329	WB Only Fifty Fifty	2015 G	Ricarda Hundt	DE	Alexander Eck	DE
329	WB Only Fifty Fifty	2015 G	Ricarda Hundt	DE	Ricarda Hundt	DE
330	A Millennium Falcon	2022 S	Rebecca Albrecht	DE	Rebecca Albrecht	DE
331	Midnight Silentdream	2018 G	Regina Jentsch	DE	Regina Jentsch	DE
332	Thegreengrasshopper	2011 G	Jule Larsen	DE	Ella Rost	DE

Teilnehmerliste

DQHA Regionen-Futurity Nord

Start Nr.	Pferd	Jahr/SEX	Eigentümer	Nat.	Vorsteller	Nat.
332	Thegreengrasshopper	2011 G	Jule Larsen	DE	Jule Larsen	DE
333	Zanelenes Staruck	2000 M	Caitlynn Kirsten Luna Long	DE	Caitlynn Kirsten Luna Long	DE
333	Zanelenes Staruck	2000 M	Caitlynn Kirsten Luna Long	DE	Ronja Marie Liselotte Laves	DE
334	A Hot Kruzin Miracle	2018 M	Svenja Rosebrock	DE	Leonie Rosebrock	DE
334	A Hot Kruzin Miracle	2018 M	Svenja Rosebrock	DE	Svenja Rosebrock	DE
335	HC Shewiseinapril	2016 M	Lisa-Marie Fritzsche	DE	Lisa-Marie Fritzsche	DE
336	Willy Gonna Bea Star	2013 G	Silke Lippert	DE	Sarah Bode	DE
337	Littleshiningmariell	2022 M	Haylee Hoffmann	DE	Frauke Hoffmann	DE
338	Smart Freckle L Wood	2009 G	Frauke Hoffmann	DE	Haylee Hoffmann	DE

Das komplette Angebot für Western- und Freizeitreiter



Circle L

seit 1983

„Hammer“ Western Hutboxen ab Ende September 2023 lieferbar

Bereits jetzt bestellen nur **99,95 €** - solange der Vorrat reicht



hier klicken

Circle L

Westernstore & Saddlery

Heidberg 21 - 31638 Wenden

Tel.: 0 50 26-3 94 - Fax: 0 50 26-94 91 52

email: shop@circle-L.de - www.Circle-L-Saddlery.de



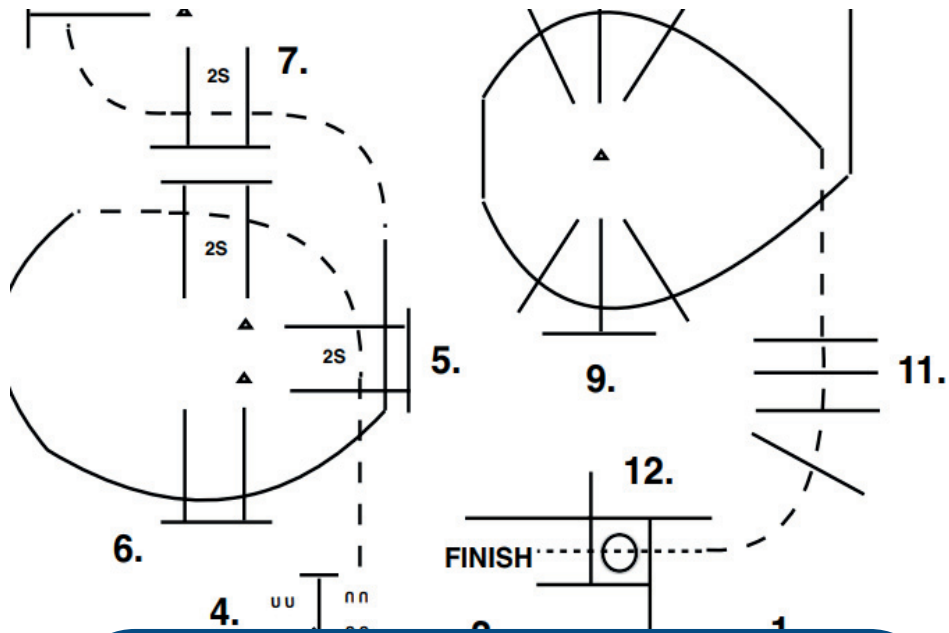

Patternbook

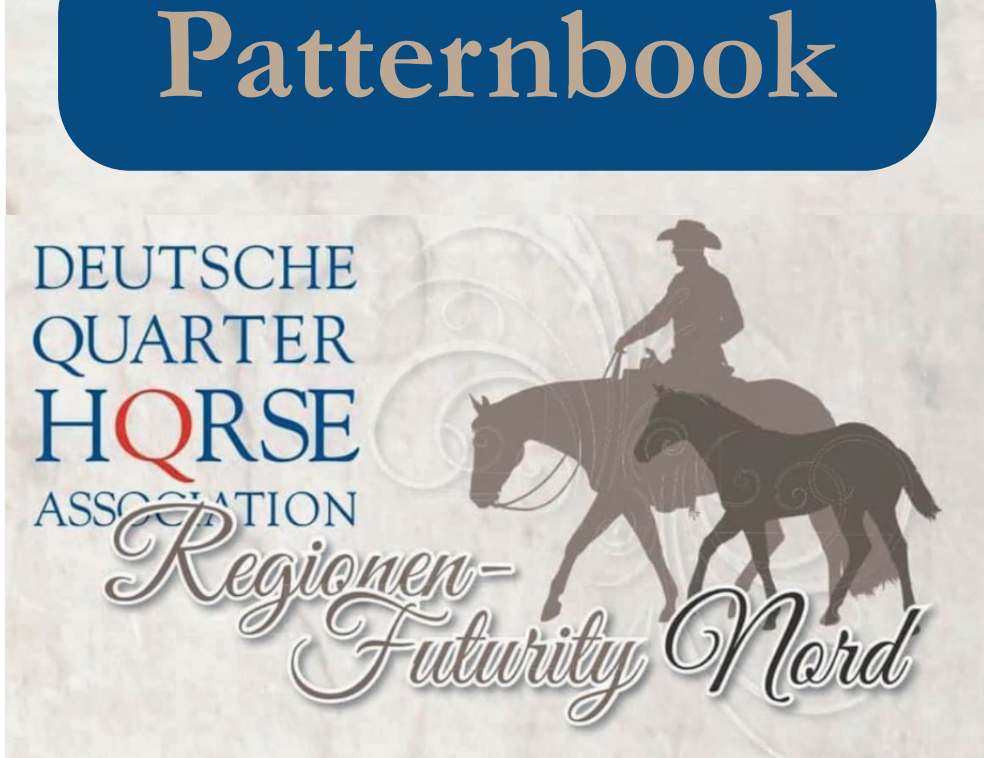

WWW.CR-SADDLES.COM

Vielen Dank für das Sponsoring und das Design unserer Pattern!



Tim Kimura
Man Of Trail



**FUTURITY - JUNIOR
L1 OPEN/AMT/YOUTH**

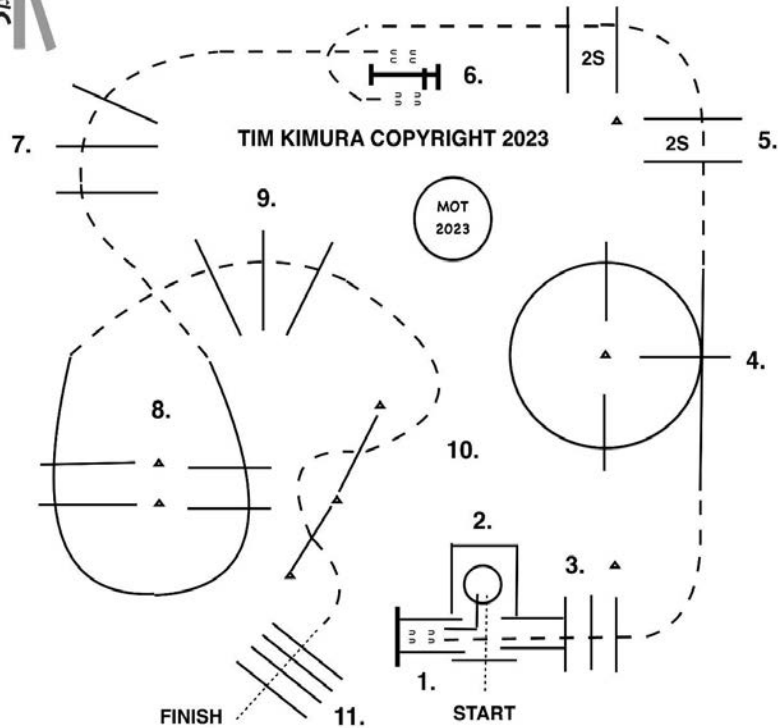

1. WALK OVER POLE, WALK INTO CHUTE, EXECUTE A 360 TURN EITHER WAY.
2. BACK AROUND CORNER, BACK BETWEEN POLES.
3. YOU MAY WALK FORWARD, THEN JOG OUT CHUTE, JOG OVER POLES.
4. LOPE OVER POLES (LEFT LEAD).
5. BREAK TO THE JOG, JOG OVER POLES.
6. JOG UP TO GATE, WORK GATE LEFT HAND.
7. JOG OVER POLES.
8. LOPE OVER POLES (RIGHT LEAD).
9. BREAK TO THE JOG, JOG OVER POLES.
10. JOG THROUGH SERPENTINE.
11. STOP OR BREAK TO THE WALK, WALK OVER POLES.

**SENIOR - AMATEUR
YOUTH - MATURITY**

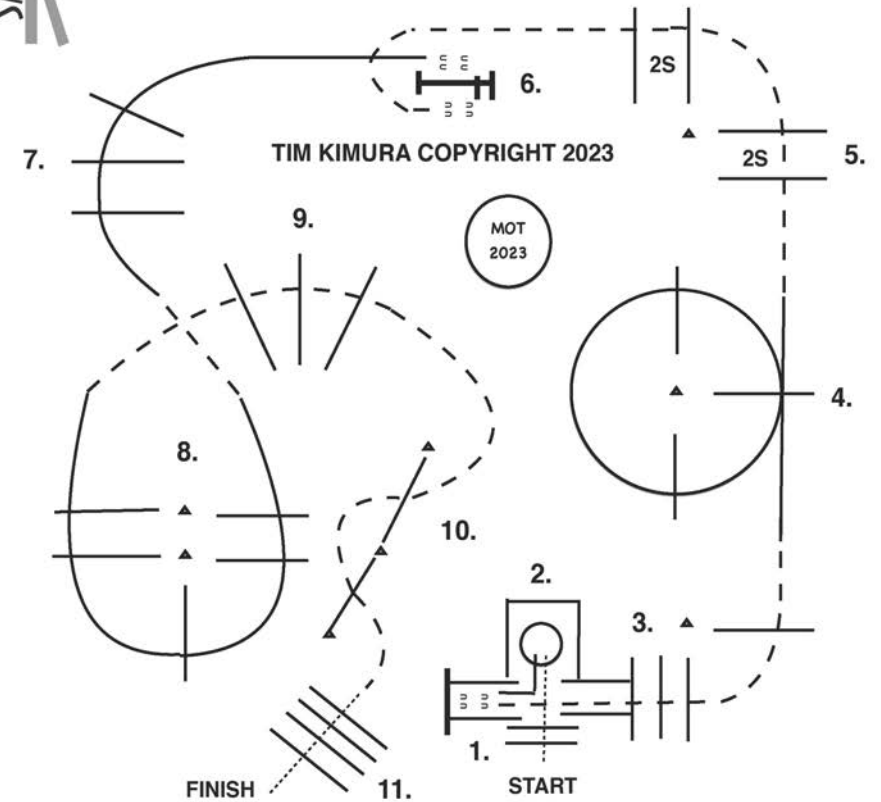

1. WALK OVER POLES, WALK INTO CHUTE, EXECUTE A 360 TURN EITHER WAY.
2. BACK AROUND CORNER, BACK BETWEEN POLES.
3. YOU MAY WALK FORWARD, THEN JOG OUT CHUTE, JOG OVER POLES.
4. LOPE OVER POLES (LEFT LEAD).
5. BREAK TO THE JOG, JOG OVER POLES.
6. JOG UP TO GATE, WORK GATE LEFT HAND.
7. LOPE OVER POLES (LEFT LEAD).
8. BREAK TO THE JOG, THEN LOPE OVER POLES (RIGHT LEAD).
9. BREAK TO THE JOG, JOG OVER POLES.
10. JOG THROUGH SERPENTINE, JOG OVER POLES.
11. STOP OR BREAK TO THE WALK, WALK OVER POLES.



In Hand TRAIL CLASSES

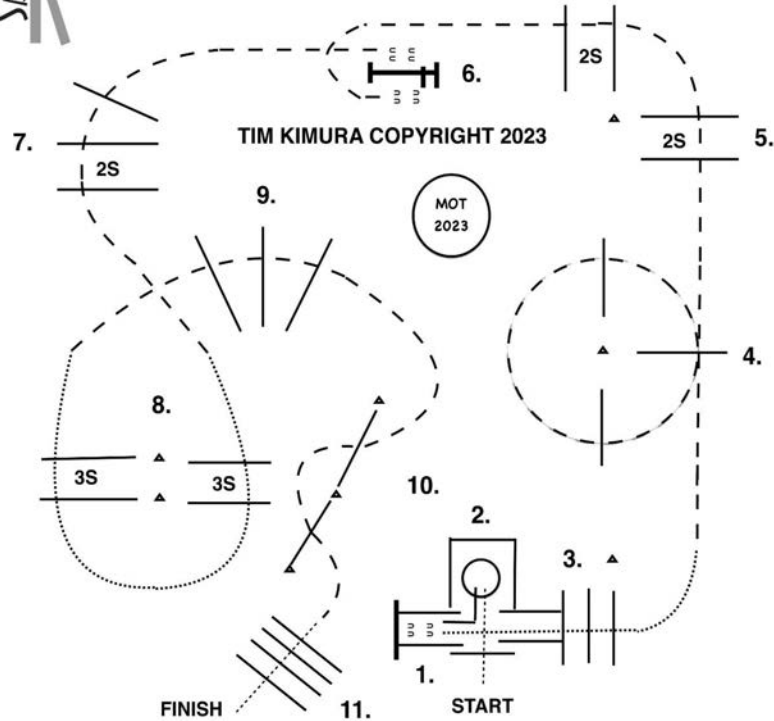

1. WALK OVER POLE, WALK INTO CHUTE, EXECUTE A 360 TURN EITHER WAY.
2. BACK AROUND CORNER, BACK BETWEEN POLES.
3. WALK OUT OF CHUTE AND OVER POLES
4. JOG OVER POLES.
5. JOG OVER POLES.
6. JOG UP TO GATE, WORK GATE LEFT HAND.
7. JOG OVER POLES.
8. WALK POLES
9. JOG OVER POLES.
10. JOG THROUGH SERPENTINE.
11. STOP OR BREAK TO THE WALK, WALK OVER POLES.



WALK TROT - L1 YOUTH

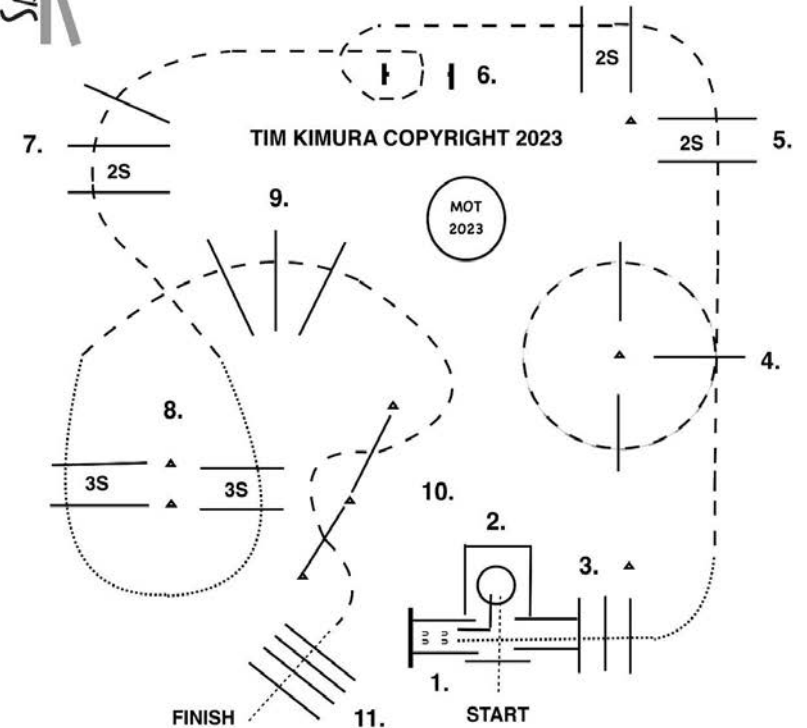

1. WALK OVER POLE, WALK INTO CHUTE, EXECUTE A 360 TURN EITHER WAY.
2. BACK AROUND CORNER, BACK BETWEEN POLES.
3. WALK OUT OF CHUTE AND OVER POLES
4. JOG OVER POLES.
5. JOG OVER POLES.
6. JOG THROUGH GATE
7. JOG OVER POLES.
8. WALK POLES
9. JOG OVER POLES.
10. JOG THROUGH SERPENTINE.
11. STOP OR BREAK TO THE WALK, WALK OVER POLES.

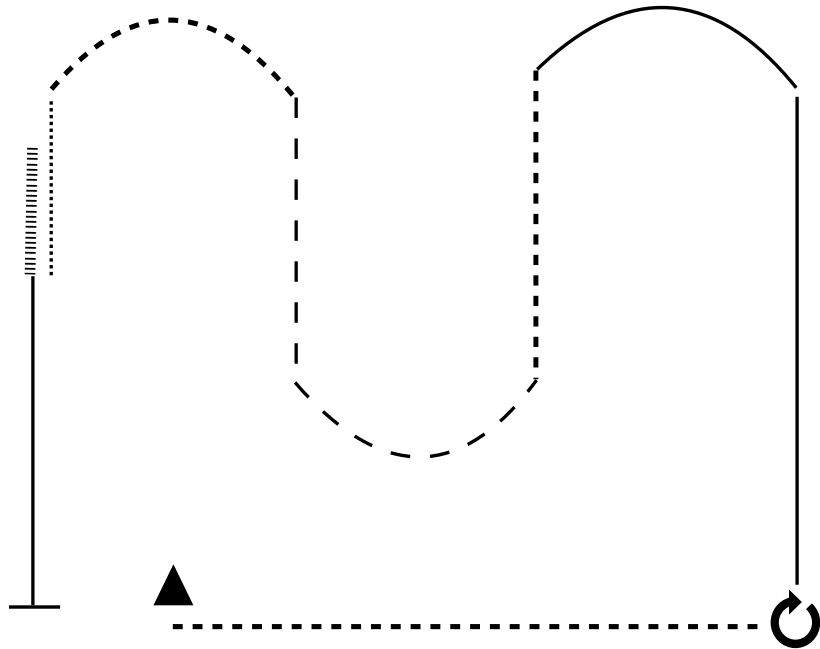

1. Be ready at cone
2. Jog on straight line
3. Stop and perform 3/4 turn to right
4. Lope left lead lope as drawn
5. Break to jog on straight line
6. Extend the jog as drawn
7. Jog around
8. Walk 1/3 of line
9. Back up one horse length
10. Lope right lead lope and stop next to cone

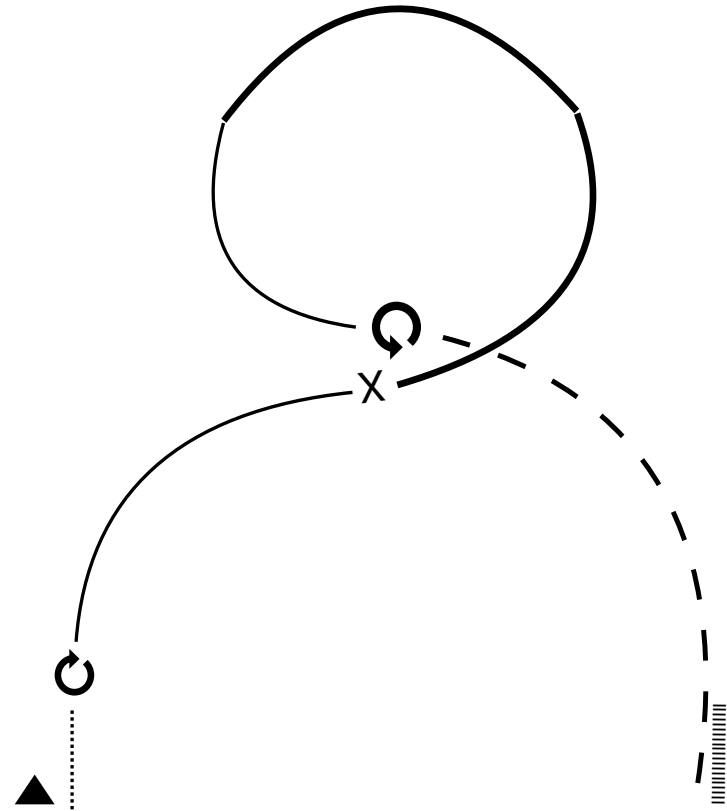

1. Be ready at cone, walk 6-8 steps, stop
2. Turn 360 right
3. Lope right lead to center
4. Perform a simple lead change
5. Extend the lope for 3/4 of the circle
6. Collect the lope
7. Stop, perform 360 turn to the left
8. Extended jog until even with cone
9. Stop and back

© Stefanie Bubenzer

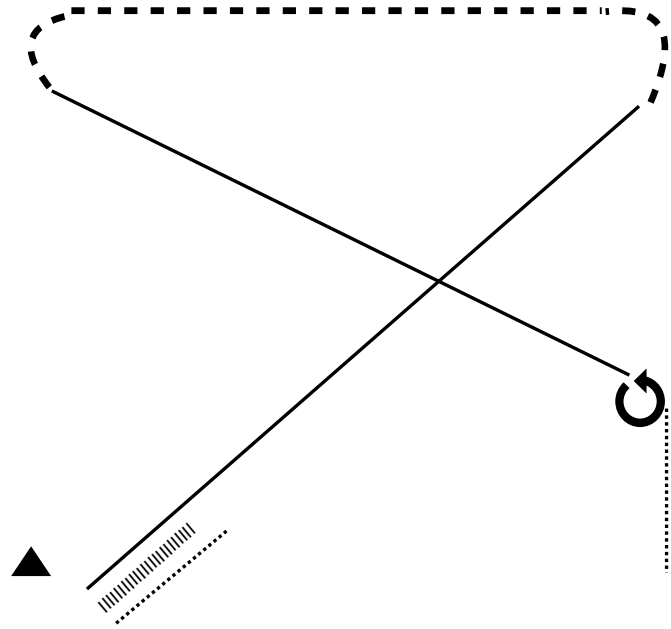

1. WALK FORWARD AT LEAST TWO HORSE LENGTHS
2. STOP AND BACK UP UP TO CONE
3. CANTER ON LEFT LEAD
4. TROT ON RIGHT DIAGONAL
5. CANTER RIGHT LEAD
6. STOP AND EXECUTE APPROXIMATELY 3/4 FOREHAND TURN TO THE LEFT
7. WALK TO EXIT

© Stefanie Bubenzer

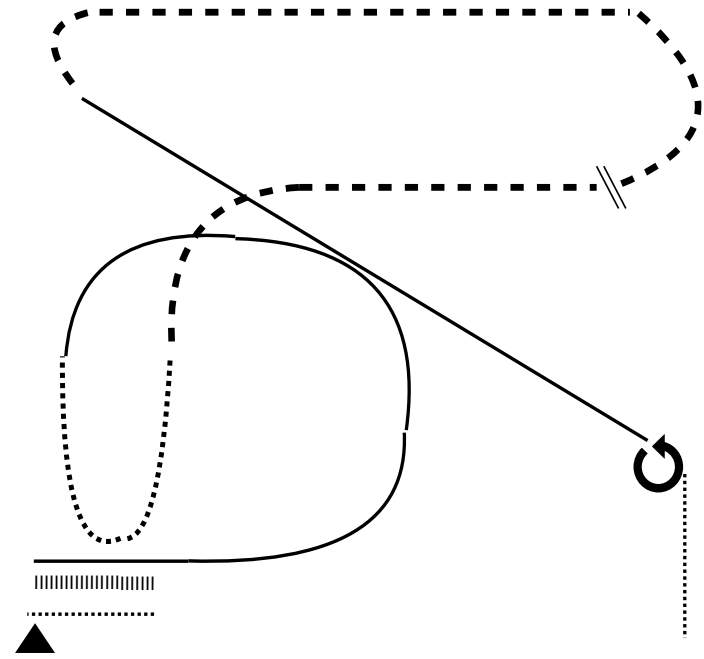

1. WALK FORWARD AT LEAST TWO HORSE LENGTHS
2. STOP AND BACK UP UP TO CONE
3. CANTER LEFT LEAD, CANTER ON A CIRCLE AS DRAWN
4. BREAK TO A WALK AND WALK LOOP
5. TROT ON LEFT DIAGONAL
6. CHANGE DIAGONAL, TROT ON RIGHT DIAGONAL
7. CANTER RIGHT LEAD
8. STOP AND EXECUTE APPROXIMATELY 3/4 FOREHAND TURN TO THE LEFT
9. WALK TO EXIT

© Stefanie Bubenzer

Ranch Riding FUTURITY/ L1 Open



RANCH RIDING - PATTERN 10

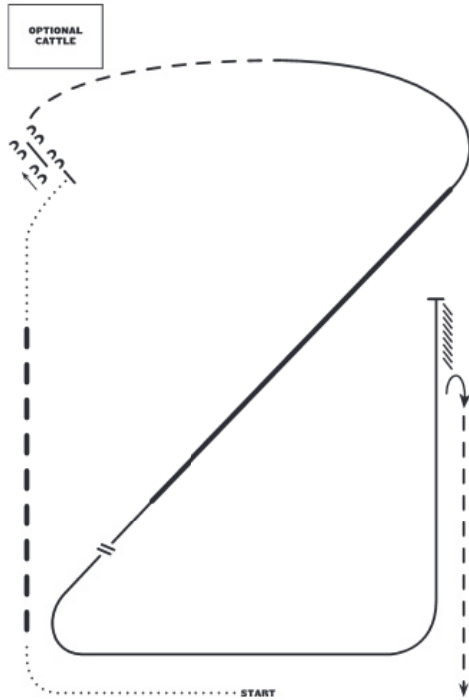

LEGEND	
.....	Walk
.....	Extended Walk
---	Trot
---	Extended Trot
---	Lope
---	Extended Lope
~~~~~	Back
W	Lead Change

1. Walk
2. Extended trot
3. Walk
4. Stop, side pass left over log
5. Trot
6. Lope right lead
7. Extended lope right lead
8. Collect lope and change leads (simple or flying)
9. Lope left lead
10. Stop and back
11. 1/2 turn right
12. Trot

*Note: The drawn description of this pattern is only intended for the general depiction of the pattern. Exhibitors should utilize the arena space to best exhibit their horses.*

# Ranch Riding MATURITY/ Open



RANCH RIDING - PATTERN 12

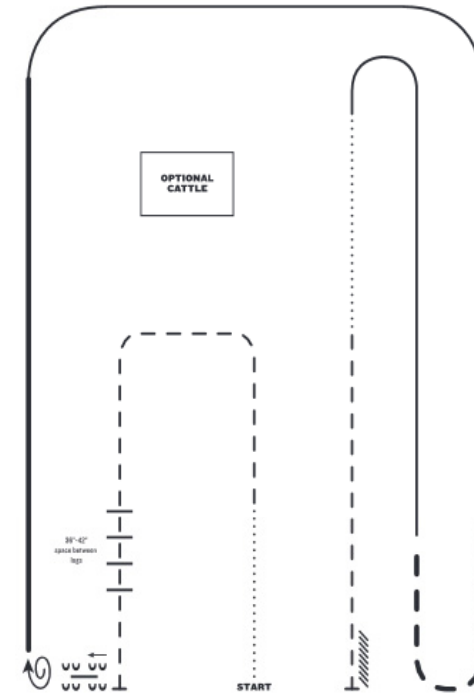

LEGEND	
.....	Walk
.....	Extended Walk
---	Trot
---	Extended Trot
---	Lope
---	Extended Lope
~~~~~	Back
W	Lead Change

1. Walk
2. Trot
3. Trot over logs, stop
4. Side pass right over log
5. 1/2 turn right
6. Extended lope right lead
7. Lope right lead
8. Extended trot
9. Lope left lead
10. Walk
11. Trot
12. Stop and back

Note: The drawn description of this pattern is only intended for the general depiction of the pattern. Exhibitors should utilize the arena space to best exhibit their horses.

RANCH RIDING - PATTERN 4

L1 Amateur/ L1 Youth

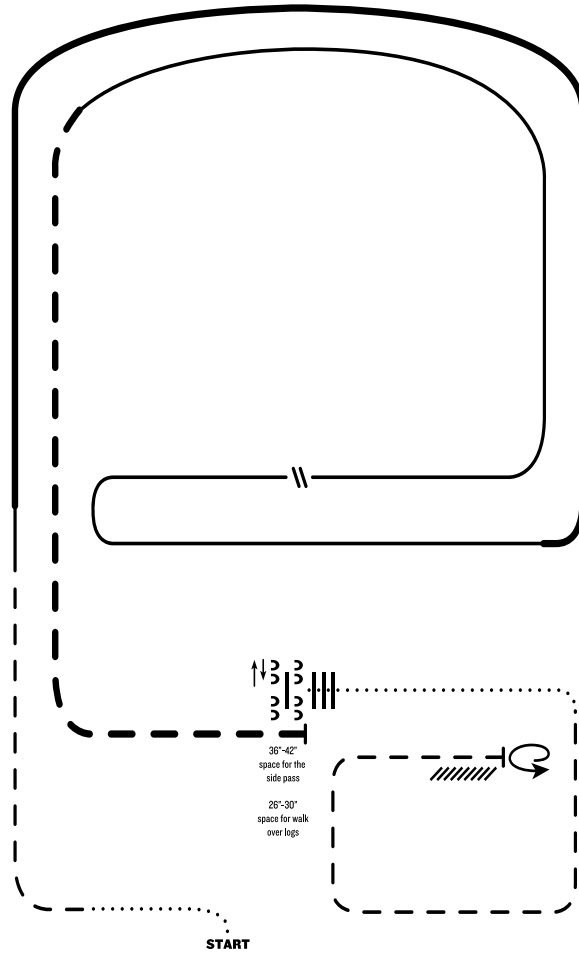

LEGEND

.....	Walk
.....	Extended Walk
- - -	Trot
- - -	Extended Trot
—	Lope
—	Extended Lope
////	Back
//	Lead Change

1. Walk
2. Trot
3. Extended lope right lead
4. Lope right lead
5. Change leads (simple or flying)
6. Lope left lead
7. Extended trot
8. Stop, side pass left, side pass right, 1/2 way
9. Walk over logs
10. Walk
11. Trot square
12. Stop, 360° turn left, and back

Note: The drawn description of this pattern is only intended for the general depiction of the pattern. Exhibitors should utilize the arena space to best exhibit their horses.

Revised 05-2021

RANCH RIDING - PATTERN 8

Amateur/Youth

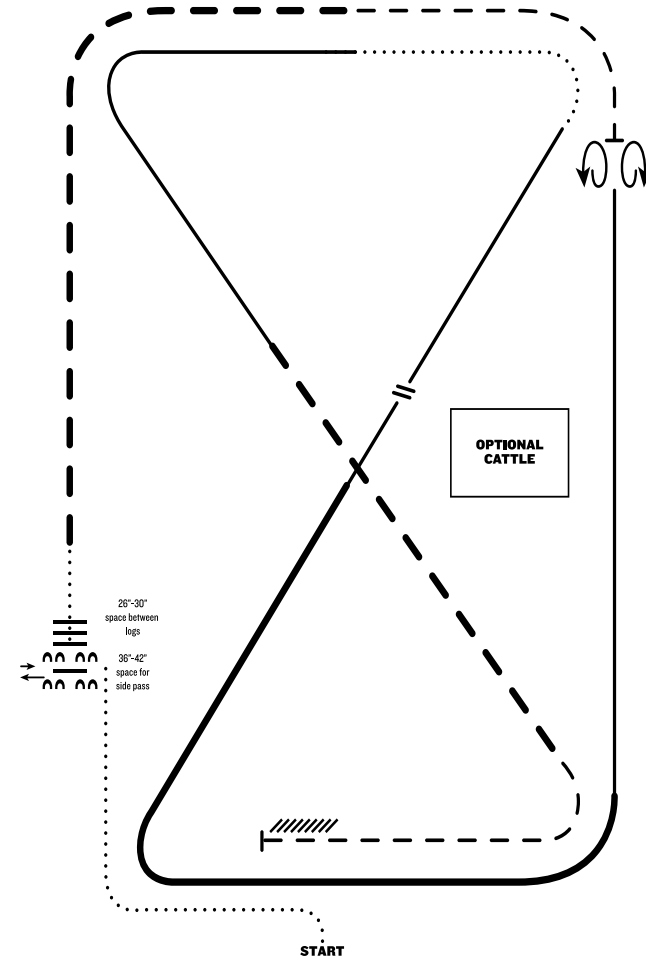

LEGEND

.....	Walk
.....	Extended Walk
- - -	Trot
- - -	Extended Trot
—	Lope
—	Extended Lope
////	Back
//	Lead Change

1. Walk
2. Side pass left across first log, side pass 1/2 way to right
3. Walk over logs
4. Extended trot
5. Trot
6. Stop, 360° turn each direction (either direction 1st) (L-R or R-L)
7. Lope right lead
8. Extended lope right lead
9. Collect lope, change leads (simple or flying), continue lope left lead
10. Walk
11. Lope left lead
12. Extended trot
13. Trot
14. Stop and back

Note: The drawn description of this pattern is only intended for the general depiction of the pattern. Exhibitors should utilize the arena space to best exhibit their horses.

Revised 05-2021

Pattern aus dem Regelbuch

Reining:

- #8 L1 Open, L1 Amateur, Reining Futurity
- #13 Open, Maturity, Amateur
- #5 L1 Youth, Youth

Western Riding:

- #5 Futurity, Maturity
- L1 #1 L1 Open, L1 Amateur, L1 Youth
- #1 Open, Amateur, Youth

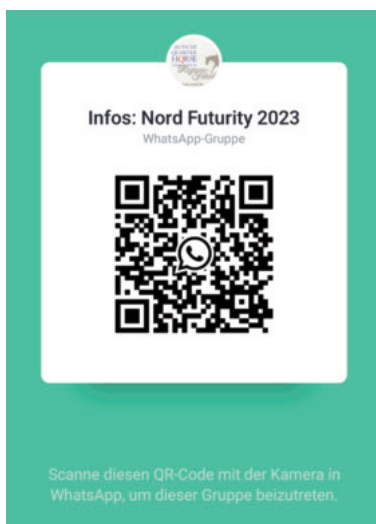

Hinweis: Dies ist NICHT die Startreihenfolge

Startlisten

DQHA Regionen-Futurity Nord

01.09.2023 bis 03.09.2023

DQHA 9002 Longe Line 2year Old Futurity					02.09.2023 Anzahl Starter: 12		
Start Nr.	Pferd von	Jahr aus	Sex	Vorsteller	Land Züchter	Eigentümer	Land
268	Blumotion Aint It The Blues	2021	G	Alexander Eck Diva Donna	DE	Alexander Eck Eck; Alexander	DE
270	Keep Distance Keep On Kruzin	2021	G	Alexandra Jagfeld Radical Tigeress	DE	Jagfeld Quarter Horses Jagfeld Quarter Horses	DE
282	Show Me The Moonlite Itsasouthernimpulse	2021	G	Sandra Semmler WFR Dexters Belle	DE	Sandra Semmler Kortmann; Janine	DE
289	Mec Peppysotwilliam Third Hot Step	2021	S	Lea Mecklenborg Peppys Tari Doc	DE	Oliver Mecklenborg Mecklenborg; Oliver	DE
291	HC Born Western Born To Be Blazing	2021	M	Lisa Hinrichs Gorgeous Invitation	DE	Lisa Hinrichs Kurzrock; Bjoern	DE
292	Blazing Lovemachine Blaze Em On	2021	M	Emma Lucie Ehlers Doubles Machine	DE	Morten Ehlers Hoffmeister; Cornelia	DE
295	Hotlines Only Diesel Only	2021	S	Joanna Precht Be My Choco Hotline	DE	Joanna Precht Eck; Alexander	DE
296	Good Lopen Lady Unexpected	2021	M	Fee Kleine Lady Of Revolution	DE	Tizia Hucklenbroch Hucklenbroch; Tizia	DE
300	Aint Your Mama Aint It The Blues	2021	M	Alexander Eck Only A Diva	DE	Fine Art QH Fine Art QH	DE
304	Ridingonawiselydream TFR A Wisely Dream	2021	M	Kim Blockus Riding On Dreams	DE	Saskia Puls Loiti Lamprecht; Christoph	DE
310	Daddys Machine Mechanic	2021	G	Stella Rost Consider Her Fancy	DE	Stella Rost Rost; Stella	DE
315	Licence To Kiss Kissin The Girls	2021	G	Katharina Schulze Only Blonde Invited	DE	Katharina Schulze Middel; Michael	DE

Hinweis: Dies ist NICHT die Startreihenfolge

Startlisten

DQHA Regionen-Futurity Nord

01.09.2023 bis 03.09.2023

DQHA 9003 Longe Line 3year Old Futurity							02.09.2023 Anzahl Starter: 11
Start Nr.	Pferd von	Jahr aus	Sex	Vorsteller	Land Züchter	Eigentümer	Land
120	Its A Goodbar Thing Mechanic	2020	G	Barbara Ceusters	BE	Nancy Van Aken	BE
149	DR Harley Quinn Greatmindsthinkaluke	2020	M	Lara Daekena	DE	Lara Daekena	DE
196	Girlsnight Hotroddin Invitation	2020	M	Nikola Buerig	DE	Nikola Buerig	DE
269	Tinn Cup Rojo Solo Cup	2020	M	Alexander Eck	DE	Alena Albrecht	DE
271	HC Lilly Be Invited Willy Be Invited	2020	M	Caroline Kretzschmar	DE	Caroline Kretzschmar	DE
288	Invite Me Solo Rojo Solo Cup	2020	G	Alexandra Jagfeld	DE	Philipp Roos	CH
298	Only Best Of Thing Its A Southern Thing	2020	M	Laura Sasse	DE	Laura Sasse	DE
309	Dream Of Midnight TFR A Wisely Dream	2020	G	Regina Jentsch	DE	Regina Jentsch	DE
318	QT Smart Spike Best Spook	2020	G	Doreen Seevogel	DE	Doreen Seevogel	DE
320	Need I Luke Good Greatmindsthinkaluke	2020	G	Christin Wendelken	DE	Christin Wendelken	DE
326	HC Grace Kelly Kissin The Girls	2020	M	Louisa Heinsch	DE	Louisa Heinsch	DE

Startlisten

DQHA Regionen-Futurity Nord

01.09.2023 bis 03.09.2023

DQHA 9031 Futurity Yearling Stallions							02.09.2023 Anzahl Starter: 2
Start Nr.	Pferd von	Jahr aus	Sex	Vorsteller	Land Züchter	Eigentümer	Land
276	WB Smooth Oreo Smooth N Cody	2022	S	Christine Petersen	DE	Christine Petersen	DE
277	WB Long John Silver CL Scotch Bar Shine	2022	S	Clemens Huebner	DE	Christine Petersen	DE

Startlisten

DQHA Regionen-Futurity Nord

01.09.2023 bis 03.09.2023

DQHA 9032 Futurity Two Year Old Stallions							02.09.2023 Anzahl Starter: 2
Start Nr.	Pferd von	Jahr aus	Sex	Vorsteller	Land Züchter	Eigentümer	Land
289	Mec Peppyshtwilliam Third Hot Step	2021	S	Lea Mecklenborg	DE	Oliver Mecklenborg	DE
295	Hotlines Only Diesel Only	2021	S	Joanna Precht	DE	Joanna Precht	DE

DQHA-Nord Futurity

32

DQHA-Nord Futurity

Hinweis: Dies ist NICHT die Startreihenfolge

Startlisten

DQHA Regionen-Futurity Nord

01.09.2023 bis 03.09.2023

DQHA 9053 Futurity Weanling Mares							02.09.2023 Anzahl Starter: 2
Start Nr.	Pferd von	Jahr aus	Sex	Vorsteller	Land Züchter	Eigentümer	Land
294	Best Shine Of Glory Bank On The Best	2023	M	Nina Doert	DE	Nina Doert	DE
324	JT Technical Spot On Spotlight Charly	2023	M	Svenja Rebecca Jordan	DE	Svenja Rebecca Jordan	DE

Startlisten

DQHA Regionen-Futurity Nord

01.09.2023 bis 03.09.2023

DQHA 9054 Futurity Yearling Mares							02.09.2023 Anzahl Starter: 2
Start Nr.	Pferd von	Jahr aus	Sex	Vorsteller	Land Züchter	Eigentümer	Land
293	Blue Shine Of Glory VS Code Blue	2022	M	Nina Doert	DE	Nina Doert	DE
328	VS Dear Blue Darling VS Code Blue	2022	M	Caroline Seidel	DE	Caroline Seidel	DE

Startlisten

DQHA Regionen-Futurity Nord

01.09.2023 bis 03.09.2023

DQHA 9055 Futurity Two Year Old Mares							02.09.2023 Anzahl Starter: 8
Start Nr.	Pferd von	Jahr aus	Sex	Vorsteller	Land Züchter	Eigentümer	Land
143	DM Molly Malone Keep On Kruzin	2021	M	Janine Kortmann	DE	Janine Kortmann	DE
291	HC Born Western Gorgeous Invitation	2021	M	Lisa Hinrichs	DE	Lisa Hinrichs	DE
292	Blazing Lovemachine Blaze Em On	2021	M	Emma Lucie Ehlers	DE	Morten Ehlers	DE
296	Good Lopen Lady Unexpected	2021	M	Fee Kleine	DE	Tizia Hucklenbroch	DE
300	Aint Your Mama Aint It The Blues	2021	M	Alexander Eck	DE	Fine Art QH	DE
304	Ridingonawiselydream TFR A Wisely Dream	2021	M	Kim Blockus	DE	Saskia Puls Loiti	DE
311	BB Blazin Blaze Em On	2021	M	Stella Rost	DE	Arthur Or Ines Melcher	DE
321	MJ Princess Blue VS Code Blue	2021	M	Philipp Dammann	DE	Andreas Heinrich	DE

DQHA-Nord Futurity

33

DQHA-Nord Futurity

Hinweis: Dies ist NICHT die Startreihenfolge

Startlisten

DQHA Regionen-Futurity Nord

01.09.2023 bis 03.09.2023

DQHA 9056 Futurity Three Year Old Mares							02.09.2023 Anzahl Starter: 8
Start Nr.	Pferd von	Jahr aus	Sex	Vorsteller	Land Züchter	Eigentümer	Land
149	DR Harley Quinn Greatmindstinkaluke	2020	M	Lara Daekena	DE	Lara Daekena	DE
196	Girlsnight Hotroddin Invitation	2020	M	Nikola Buerig	DE	Nikola Buerig	DE
269	Tinn Cup Rojo Solo Cup	2020	M	Alexander Eck	DE	Alena Albrecht	DE
271	HC Lilly Be Invited Willy Be Invited	2020	M	Caroline Kretzschmar	DE	Caroline Kretzschmar	DE
285	Its Automatic Mechanic	2020	M	Finja Hoerich	DE	Angelina Siemon	DE
298	Only Best Of Thing Its A Southern Thing	2020	M	Laura Sasse	DE	Laura Sasse	DE
325	AM Precious Addicting Wisely	2020	M	Franziska Hattensauer	DE	Franziska Hattensauer	DE
326	HC Grace Kelly Kissin The Girls	2020	M	Louisa Heinsch	DE	Louisa Heinsch	DE

Startlisten

DQHA Regionen-Futurity Nord

01.09.2023 bis 03.09.2023

DQHA 9074 Futurity Yearling Geldings							02.09.2023 Anzahl Starter: 2
Start Nr.	Pferd von	Jahr aus	Sex	Vorsteller	Land Züchter	Eigentümer	Land
278	MD Invitemetotexas Zippos Good Mr	2022	G	Anna-Elisabeth Laves	DE	Dietmar & Maria Friedh	DE
322	Scotch An Moonlite Only In The Moonlite	2022	G	Sarah Bode	DE	Daniela Rohrseitz	DE

Hinweis: Dies ist NICHT die Startreihenfolge

Startlisten

DQHA Regionen-Futurity Nord

01.09.2023 bis 03.09.2023

DQHA 9075 Futurity Two Year Old Geldings							02.09.2023 Anzahl Starter: 5
Start Nr.	Pferd von	Jahr aus	Sex	Vorsteller	Land Züchter	Eigentümer	Land
268	Blumotion Aint It The Blues	2021	G	Alexander Eck	DE	Alexander Eck	DE
270	Keep Distance Keep On Kruzin	2021	G	Alexandra Jagfeld	DE	Jagfeld Quarter Horses	DE
282	Show Me The Moonlite Itsasouthernimpulse	2021	G	Sandra Semmler	DE	Sandra Semmler	DE
310	Daddys Machine Mechanic	2021	G	Stella Rost	DE	Stella Rost	DE
315	Licence To Kiss Kissin The Girls	2021	G	Katharina Schulze	DE	Katharina Schulze	DE

Startlisten

DQHA Regionen-Futurity Nord

01.09.2023 bis 03.09.2023

DQHA 9076 Futurity Three Year Old Geldings							02.09.2023 Anzahl Starter: 6
Start Nr.	Pferd von	Jahr aus	Sex	Vorsteller	Land Züchter	Eigentümer	Land
120	Its A Goodbar Thing Mechanic	2020	G	Barbara Ceusters	BE	Nancy Van Aken	BE
279	Candys Magic Shine CL Scotch Bar Shine	2020	G	Anna-Elisabeth Laves	DE	Dietmar & Maria Friedh	DE
288	Invite Me Solo Rojo Solo Cup	2020	G	Alexandra Jagfeld	DE	Philipp Roos	CH
297	Snuggle In Motion Imagimotion	2020	G	Sarah De Weerd	NL	Nadja Lamers	DE
309	Dream Of Midnight TFR A Wisely Dream	2020	G	Regina Jentsch	DE	Regina Jentsch	DE
320	Need I Luke Good Greatmindstinkaluke	2020	G	Christin Wendelken	DE	Christin Wendelken	DE

Hinweis: Dies ist NICHT die Startreihenfolge

Startlisten

DQHA Regionen-Futurity Nord

01.09.2023 bis 03.09.2023

DQHA 9381 Trail Futurity		03.09.2023 Anzahl Starter: 16					
Start Nr.	Pferd von	Jahr aus	Sex	Vorsteller	Land	Eigentümer	Land
					Züchter		
118	Nobodyz Business Its A Southern Thing	2019	G	Barbara Ceusters	BE	Nancy Van Aken	BE
				Versions Of Bay Lady	Maisonnette; David		
123	In My Blood Original Cowboy	2018	M	Barbara Ceusters	BE	Nancy Van Aken	BE
				Page N Machine	Maisonnette; David		
168	Hotkrymsuninvestment One Hot Krymsun	2018	G	Hauke Themer	DE	Hauke Themer	DE
				Absolute Allure	Weissenbacher; Karl & Sonja		
178	An Undeniably Mayday Blaze Em On	2018	G	Serafine Zodrow	DE	Serafine Zodrow	DE
				Hints Rosita Sabre	Kuesters; Bianca		
195	Marylou Rocks The Rock	2019	M	Nikola Buerig	DE	Nikola Buerig	DE
				One Hot Celebrity	Pot; Brigitte		
275	Hotkrymsunpotential One Hot Krymsun	2019	G	Sandra Kaden	DE	Sandra Kaden	DE
				Certainlyflirtatious	Weissenbacher; Karl & Sonja		
283	A Dream Of Jeannie Born To Be Blazing	2018	G	Angelina Siemon	DE	Finja Hoerich	DE
				Jeannie In A Bottle	4 You Quarter Horses		
284	Spot Dot Com Disavowed	2017	G	Angelina Siemon	DE	Janina Mueller	DE
				Libbitimpulsive	Fischer; Britta And Guenter		
286	Marlanas Hot Iron Best Irons Are Hot	2017	M	Janine Kothe	DE	Janine Kothe	DE
				Jobi Power	Seidel; Caroline		
287	Keep On Rocknroll Keep On Kruzin	2017	G	Alexandra Jagfeld	DE	Philipp Roos	CH
				I Love Rock N Roll	Reith; Sabine		
301	Kissesinthemoonlight Only In The Moonlite	2019	M	Alexander Eck	DE	Fine Art QH	DE
				Zips Radical Cutie	Haier; Torsten		
303	KrymsunBlazinMachine Only Krymsun	2017	G	Kim Blockus	DE	Kim Blockus	DE
				Hot Blazin Machine	Blockus; Kim		
305	GQH Hez Good Too Hotroddin Invitation	2019	G	Kim Blockus	DE	Kathrin Roesel	DE
				Shez Good Too	Georgi Quarter Horses		
307	Mec Me Happy Mechanic	2019	G	Leana Brasseler	DE	Adrien Delporte	BE
				CC Emma Star	Leroux; Cedric		
308	Minnie Mouze Disavowed	2019	M	Leana Brasseler	DE	Fine Art QH	DE
				Dressed To Be Best	Fischer; Britta And Guenter		
313	Gunwilsons Queeny Gunnerito	2018	M	Sabrina Busch	DE	Sabrina Busch	DE
				CC Queen	Kochinke; Frank		

Startlisten

DQHA Regionen-Futurity Nord

01.09.2023 bis 03.09.2023

DQHA 9382 Trail Maturity		03.09.2023 Anzahl Starter: 3					
Start Nr.	Pferd von	Jahr aus	Sex	Vorsteller	Land	Eigentümer	Land
					Züchter		
138	Got Southern Credit Its A Southern Thing	2015	G	Arne Kuehn	DE	Amelie Busse	DE
				Ive Got Good Credit	Maisonnette; David		
327	Struttin To My Blues Aint It The Blues	2015	M	Angelina Siemon	DE	Monika Knipschild	DE
				Pansy Connection	Seeler; Reinhold		
329	WB Only Fifty Fifty Only Invitational	2015	G	Alexander Eck	DE	Ricarda Hundt	DE
				Zippos Hot Krymsun	Kuenstler; Maike		

DQHA-Nord Futurity

36

DQHA-Nord Futurity

Hinweis: Dies ist NICHT die Startreihenfolge

Startlisten

DQHA Regionen-Futurity Nord

01.09.2023 bis 03.09.2023

DQHA 9421 Pleasure Futurity		02.09.2023 Anzahl Starter: 17					
Start Nr.	Pferd von	Jahr aus	Sex	Vorsteller	Land	Eigentümer	Land
					Züchter		
102	VS Loveline VS Flatline	2018	M	Joanna Rohwer	DE	Joanna Rohwer	DE
				Dressed Like N Angel	Drangmeister; Nina		
118	Nobodyz Business Its A Southern Thing	2019	G	Barbara Ceusters	BE	Nancy Van Aken	BE
				Versions Of Bay Lady	Maisonnette; David		
123	In My Blood Original Cowboy	2018	M	Nancy Van Aken	BE	Nancy Van Aken	BE
				Page N Machine	Maisonnette; David		
168	Hotkrymsuninvestment One Hot Krymsun	2018	G	Hauke Themer	DE	Hauke Themer	DE
				Absolute Allure	Weissenbacher; Karl & Sonja		
178	An Undeniably Mayday Blaze Em On	2018	G	Serafine Zodrow	DE	Serafine Zodrow	DE
				Hints Rosita Sabre	Kuesters; Bianca		
195	Marylou Rocks The Rock	2019	M	Nikola Buerig	DE	Nikola Buerig	DE
				One Hot Celebrity	Pot; Brigitte		
274	Zippos Pretty Rosie Zippos Good Mr	2017	M	Patricia Klischan-Tornquist	DE	Patricia Klischan-Tornquist	DE
				LF More Image	Wendelken; Christin		
275	Hotkrymsunpotential One Hot Krymsun	2019	G	Sandra Kaden	DE	Sandra Kaden	DE
				Certainlyflirtatious	Weissenbacher; Karl & Sonja		
280	HC Remember Me Sexy HC Sexy Sudden	2018	M	Lena Soehngen	DE	Soehngen Lena And Joha	DE
				Vested Jewel	Kurzrock; Bjoern		
283	A Dream Of Jeannie Born To Be Blazing	2018	G	Finja Hoerich	DE	Finja Hoerich	DE
				Jeannie In A Bottle	4 You Quarter Horses		
284	Spot Dot Com Disavowed	2017	G	Angelina Siemon	DE	Janina Mueller	DE
				Libbitimpulsive	Fischer; Britta And Guenter		
286	Marlanas Hot Iron Best Irons Are Hot	2017	M	Janine Kothe	DE	Janine Kothe	DE
				Jobi Power	Seidel; Caroline		
287	Keep On Rocknroll Keep On Kruzin	2017	G	Alexandra Jagfeld	DE	Philipp Roos	CH
				I Love Rock N Roll	Reith; Sabine		
301	Kissesinthemoonlight Only In The Moonlite	2019	M	Alexander Eck	DE	Fine Art QH	DE
				Zips Radical Cutie	Haier; Torsten		
303	KrymsunBlazinMachine Only Krymsun	2017	G	Kim Blockus	DE	Kim Blockus	DE
				Hot Blazin Machine	Blockus; Kim		
305	GQH Hez Good Too Hotroddin Invitation	2019	G	Kathrin Roesel	DE	Kathrin Roesel	DE
				Shez Good Too	Georgi Quarter Horses		
308	Minnie Mouze Disavowed	2019	M	Leana Brasseler	DE	Fine Art QH	DE
				Dressed To Be Best	Fischer; Britta And Guenter		

DQHA-Nord Futurity

37

DQHA-Nord Futurity

Hinweis: Dies ist NICHT die Startreihenfolge

Startlisten

DQHA Regionen-Futurity Nord

01.09.2023 bis 03.09.2023

DQHA 9422 Pleasure Maturity							03.09.2023 Anzahl Starter: 4
Start Nr.	Pferd von	Jahr aus	Sex	Vorsteller	Land Züchter	Eigentümer	Land
138	Got Southern Credit Its A Southern Thing	2015	G	Arne Kuehn	DE	Amelie Busse Maisonnette; David	DE
314	TL Onehot Investment Investing Wisely	2014	M	Luca Kempfer	DE	Luca Kempfer Roth-Leckebusch; Petra	DE
316	Iota Wisely Invested Investing Wisely	2016	G	Katharina Schulze	DE	Katharina Schulze Mueller; Horst	DE
327	Struttin To My Blues Aint It The Blues	2015	M	Carolin Knipschild	DE	Monika Knipschild Seeler; Reinhold	DE

Startlisten

DQHA Regionen-Futurity Nord

01.09.2023 bis 03.09.2023

DQHA 9431 Ranch Riding Futurity							01.09.2023 Anzahl Starter: 3
Start Nr.	Pferd von	Jahr aus	Sex	Vorsteller	Land Züchter	Eigentümer	Land
214	Best Spark Best Spook	2017	G	Anna-Lena Barre	DE	Jan-Niklas Barre Koeppen-Hoeckling; Heike	DE
302	Electricmajesticflow IJ Rocky Steeldust	2017	G	Solveig Katharina Muke	DE	Maren Matern Matern; Rene	DE
313	Gunwilsons Queeny Gunnerito	2018	M	Sabrina Busch	DE	Sabrina Busch Kochinke; Frank	DE

Hinweis: Dies ist NICHT die Startreihenfolge

Startlisten

DQHA Regionen-Futurity Nord

01.09.2023 bis 03.09.2023

DQHA 9441 Hunter Under Saddle Futurity							01.09.2023 Anzahl Starter: 12
Start Nr.	Pferd von	Jahr aus	Sex	Vorsteller	Land Züchter	Eigentümer	Land
168	Hotkrymsuninvestment One Hot Krymsun	2018	G	Hauke Themer	DE	Hauke Themer Weissenbacher; Karl & Sonja	DE
178	An Undeniably Mayday Blaze Em On	2018	G	Serafine Zodrow	DE	Serafine Zodrow Kuesters; Bianca	DE
274	Zippos Pretty Rosie Zippos Good Mr	2017	M	Patricia Klischan-Tornquist	DE	Patricia Klischan-Tornquist Wendelken; Christin	DE
275	Hotkrymsunpotential One Hot Krymsun	2019	G	Sandra Kaden	DE	Sandra Kaden Weissenbacher; Karl & Sonja	DE
280	HC Remember Me Sexy HC Sexy Sudden	2018	M	Johanna Hippe	DE	Soehngen Lena And Joha Kurzrock; Bjoern	DE
283	A Dream Of Jeannie Born To Be Blazing	2018	G	Finja Hoerich	DE	Finja Hoerich 4 You Quarter Horses	DE
284	Spot Dot Com Disavowed	2017	G	Angelina Siemon	DE	Janina Mueller Fischer; Britta And Guenter	DE
286	Marlanas Hot Iron Best Irons Are Hot	2017	M	Janine Kothe	DE	Janine Kothe Seidel; Caroline	DE
287	Keep On Rocknroll Keep On Kruzin	2017	G	Alexandra Jagfeld	DE	Philipp Roos Reith; Sabine	CH
305	GQH Hez Good Too Hotroddin Invitation	2019	G	Kim Blockus	DE	Kathrin Roesel Georgi Quarter Horses	DE
307	Mec Me Happy Mechanic	2019	G	Leana Brasseler	DE	Adrien Delporte Leroux; Cedric	BE
319	Only Made In China Hotroddin Invitation	2017	G	Sara Moslehner	DE	Sara Moslehner Georgi Quarter Horses	DE

Startlisten

DQHA Regionen-Futurity Nord

01.09.2023 bis 03.09.2023

DQHA 9442 Hunter Under Saddle Maturity							02.09.2023 Anzahl Starter: 4
Start Nr.	Pferd von	Jahr aus	Sex	Vorsteller	Land Züchter	Eigentümer	Land
138	Got Southern Credit Its A Southern Thing	2015	G	Amelie Busse	DE	Amelie Busse Maisonnette; David	DE
314	TL Onehot Investment Investing Wisely	2014	M	Luca Kempfer	DE	Luca Kempfer Roth-Leckebusch; Petra	DE
316	Iota Wisely Invested Investing Wisely	2016	G	Katharina Schulze	DE	Katharina Schulze Mueller; Horst	DE
327	Struttin To My Blues Aint It The Blues	2015	M	Carolin Knipschild	DE	Monika Knipschild Seeler; Reinhold	DE

Hinweis: Dies ist NICHT die Startreihenfolge

Startlisten

DQHA Regionen-Futurity Nord

01.09.2023 bis 03.09.2023

DQHA 93802 Trail In Hand 2year Old Futurity							02.09.2023 Anzahl Starter: 10
Start Nr.	Pferd von	Jahr aus	Sex	Vorsteller	Land Züchter	Eigentümer	Land
143	DM Molly Malone	2021	M	Janine Kortmann	DE	Janine Kortmann	DE
	Keep On Kruzin	DM Only Tender Moon		Verduin-Demol; Dikkie			
282	Show Me The Moonlite	2021	G	Sandra Semmler	DE	Sandra Semmler	DE
	Itsasouthernimpulse	WFR Dexters Belle		Kortmann; Janine			
289	Mec Peppysotwilliam	2021	S	Lea Mecklenborg	DE	Oliver Mecklenborg	DE
	Third Hot Step	Peppys Tari Doc		Mecklenborg; Oliver			
292	Blazing Lovemachine	2021	M	Morten Ehlers	DE	Morten Ehlers	DE
	Blaze Em On	Doubles Machine		Hoffmeister; Cornelia			
295	Hotlines Only	2021	S	Joanna Precht	DE	Joanna Precht	DE
	Diesel Only	Be My Choco Hotline		Eck; Alexander			
296	Good Lopen Lady	2021	M	Fee Kleine	DE	Tizia Hucklenbroch	DE
	Unexpected	Lady Of Revolution		Hucklenbroch; Tizia			
304	Ridingonawiselydream	2021	M	Kim Blockus	DE	Saskia Puls Loiti	DE
	TFR A Wisely Dream	Riding On Dreams		Lamprecht; Christoph			
310	Daddys Machine	2021	G	Stella Rost	DE	Stella Rost	DE
	Mechanic	Consider Her Fancy		Rost; Stella			
311	BB Blazin	2021	M	Stella Rost	DE	Arthur Or Ines Melcher	DE
	Blaze Em On	Buckleys Bay Bee		Melcher; Arthur Or Ines			
321	MJ Princess Blue	2021	M	Laura-Sophie Heinrich	DE	Andreas Heinrich	DE
	VS Code Blue	Princeshotchocolate		Scharf-Cheban Quarterhorses			



Hinweis: Dies ist NICHT die Startreihenfolge

Startlisten

DQHA Regionen-Futurity Nord

01.09.2023 bis 03.09.2023

DQHA 93803 Trail In Hand 3year Old Futurity							03.09.2023 Anzahl Starter: 13
Start Nr.	Pferd von	Jahr aus	Sex	Vorsteller	Land Züchter	Eigentümer	Land
120	Its A Goodbar Thing	2020	G	Nancy Van Aken	BE	Nancy Van Aken	BE
	Mechanic	Ive Got Good Credit		Maisonnette; David			
149	DR Harley Quinn	2020	M	Lara Daekena	DE	Lara Daekena	DE
	Greatmindstinkaluke	Invite Me Good Girl		Hoehn; Stefanie			
196	Girlsnight	2020	M	Nikola Buerig	DE	Nikola Buerig	DE
	Hotroddin Invitation	Elegance In Style		Buerig; Nikola			
269	Tinn Cup	2020	M	Alena Albrecht	DE	Alena Albrecht	DE
	Rojo Solo Cup	Diva Donna		Eck; Alexander			
271	HC Lilly Be Invited	2020	M	Caroline Kretzschmar	DE	Caroline Kretzschmar	DE
	Willy Be Invited	Alotta Good Scotch		Kurzrock; Bjoern			
273	Royal Ruler	2020	G	Stefanie Hoehn	DE	Stefanie Hoehn	DE
	Greatmindstinkaluke	Only Inviting Me		Hoehn; Stefanie			
279	Candys Magic Shine	2020	G	Anna-Elisabeth Laves	DE	Dietmar & Maria Friedh	DE
	CL Scotch Bar Shine	Casszipasilentcandy		Friedhoff; Dietmar & Maria			
285	Its Automatic	2020	M	Finja Hoerich	DE	Angelina Siemon	DE
	Mechanic	Hot Fashion Lady		Feller; Diane			
297	Snuggle In Motion	2020	G	Sarah De Weerd	NL	Nadja Lamers	DE
	Imagimotion	Be Mine For Certan		Jagfeld Quarter Horses			
309	Dream Of Midnight	2020	G	Regina Jentsch	DE	Regina Jentsch	DE
	TFR A Wisely Dream	Coosa Midnight Star		Jentsch; Regina			
318	QT Smart Spike	2020	G	Doreen Seevogel	DE	Doreen Seevogel	DE
	Best Spook	Frozen QT		Marienfeld; Torsten			
320	Need I Luke Good	2020	G	Christin Wendelken	DE	Christin Wendelken	DE
	Greatmindstinkaluke	LF More Image		Wendelken; Christin			
326	HC Grace Kelly	2020	M	Louisa Heinsch	DE	Louisa Heinsch	DE
	Kissin The Girls	Hot Impulse Version		Kurzrock; Bjoern			

Die DQHA Nord bedankt sich bei den



Sponsoren der Nord Futurity 2023

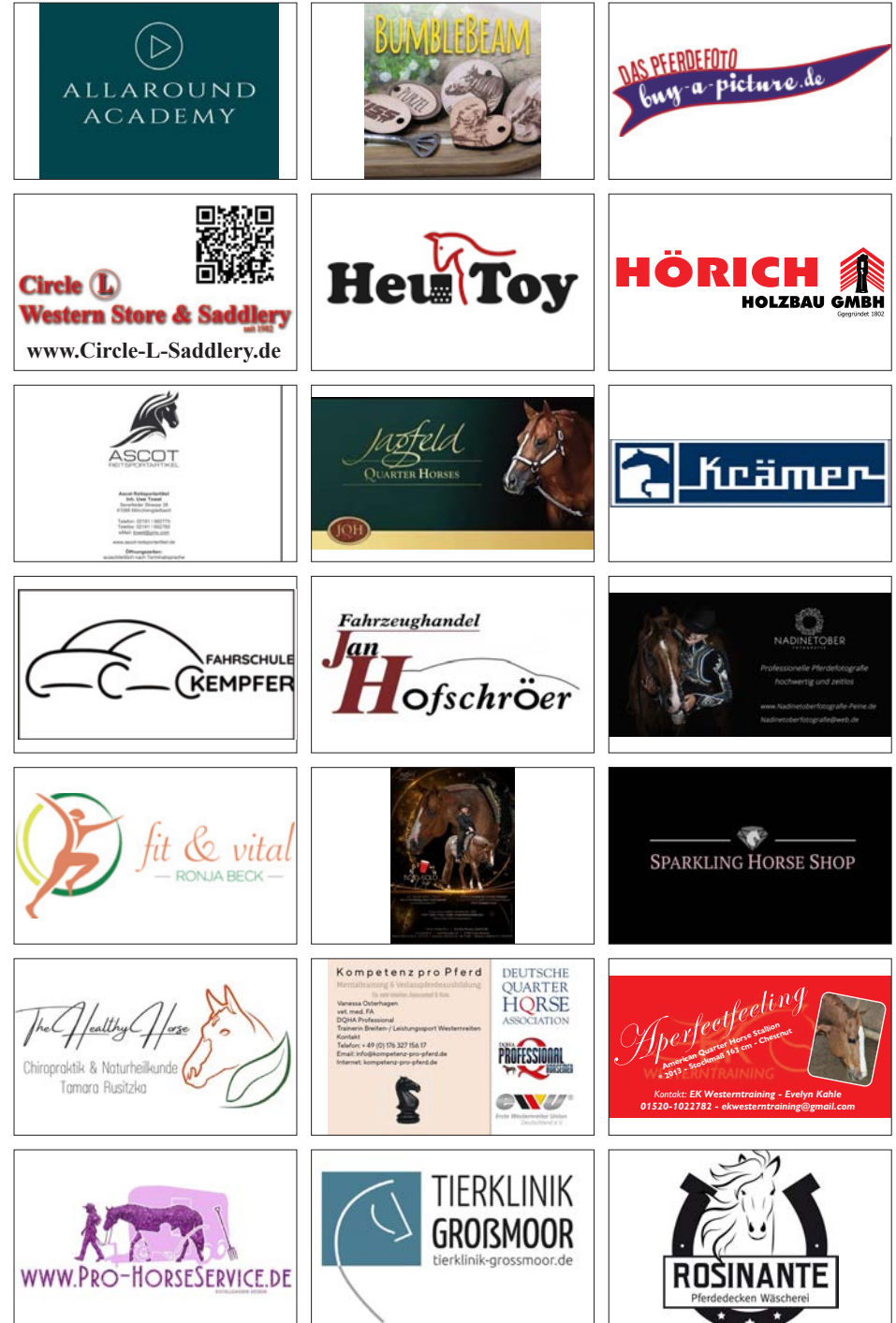



12. – 22. Oktober 2023 in Aachen

BE
A PART
OF IT

Q23 DQHA International Championship mit der DQHA Futurity/Maturity

HIGHLIGHTS

im Rahmen der Q23 in Aachen:

- Q Champion of Champions 2023
- Q DQHA Futurity/Maturity
- Q AQHA/DQHA 4-fach Show mit vielfältigem Klassenangebot
- Q Neu: Ranch Trail & Working Western Rail
- Q DQHA Hengstkörung
- Q DQHA Championate der besten Fohlen, Stuten und Wallache der Zuchtsaison 2023
- Q SSA 2023 Decksprungversteigerung

JETZT NENNEN!

Die Ausschreibung sowie Nennformulare finden Sie im Showkalender unter:

www.dqha.de



Die ganze Vielfalt des American Quarter Horse: die Q23 DQHA International Championship erwartet Sie

Die DQHA International Championship 2023 findet in diesem Jahr vom 12. bis 22. Oktober 2023 auf dem berühmten Gelände des ARLV in der Aachener Soers statt.

Züchter, Reiter und Liebhaber des American Quarter Horse zieht es nach Aachen, um sich in den prestigeträchtigen Showarenen zu messen und satte **Preisgelder aus dem DQHA Futurity-Topf** zu ergattern. Von den Weanling Klassen bis hin zu den SSA Graduate Klassen, von Halter bis Trail – ein vielfältiges Angebot wartet auf Teilnehmer und begeisterte Zuschauer. Und natürlich wird auch wieder der Champion of Champions gesucht.

Neben der Futurity erwarten interessierte Züchter und Liebhaber der Rasse die großen **Championate der Zuchtsaison 2023** – erstmals werden auch die Wallache mit einem Championat geehrt. American Quarter Horse-Hengste stellen sich der Körkommission und ermöglichen es Stuteneigentümern, ihren potentiellen Hengst für die Zuchtsaison 2024 live und in Farbe zu sehen. Dazu bietet die **Stallion Service Auction 2023** wieder die Möglichkeit, Decksprünge gefragter Hengste aus dem In- und Ausland zu ersteigern.



Foto: Laura Sophie Photo

Anspruchspartner: Elisa Frischbier | elisa.frischbier@dqha.de Mehr unter: dqha.de

Deutsche Quarter Horse Association e.V. | Daimlerstraße 22 | 63741 Aschaffenburg

